

# FLOATING FLAG POLE

By TROOP 750  
MARIETTA GA

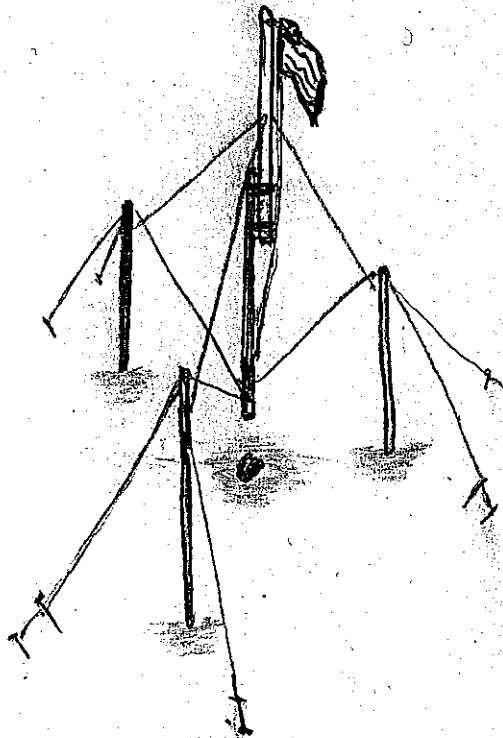

FLOATING FLAG POLE  
by D. OSBORNE

## EQUIPMENT NEEDED

- 1 PULLY
- 5 SPARES - 10'
  - 2 - FLAG POLE
  - 3 - SUPPORT POLES
- 12 STAKES
  - 6-12 HEAVY DUTY
- ROPE - 550 PARACORD - APPROX 250'

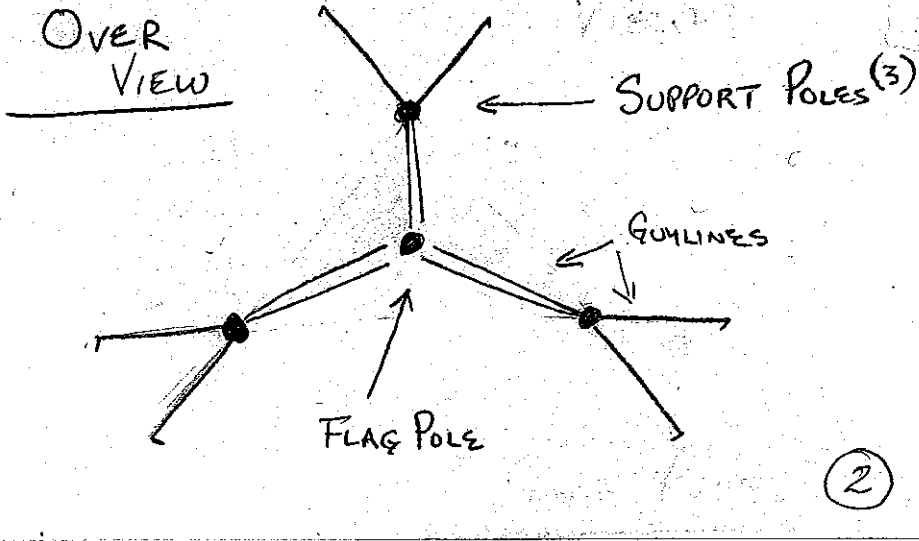

POLE LASH 2 POLES TOGETHER

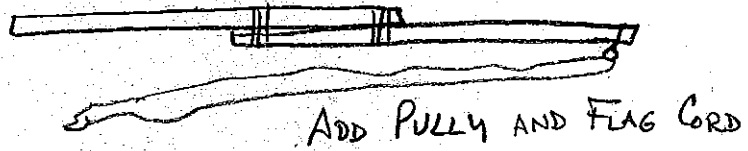

3 X'S SUPPORT POLES

LEAN INWARDS DURING SETUP UNTIL SECURED TO BOTTOM OF POLE STEP 6.

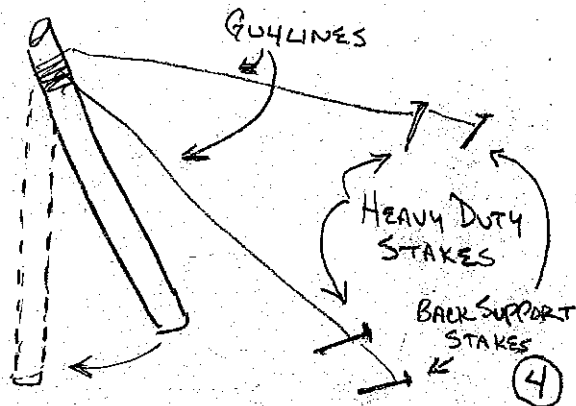

3 X'S GUYLINES TO SUPPORT POLES

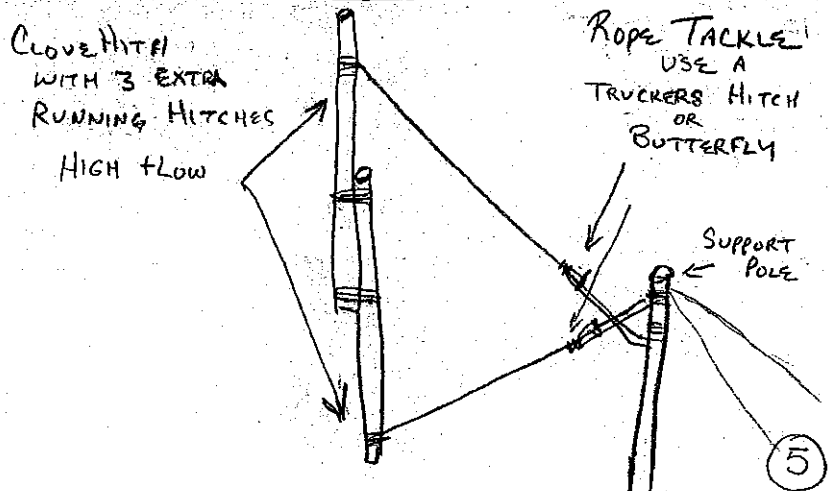

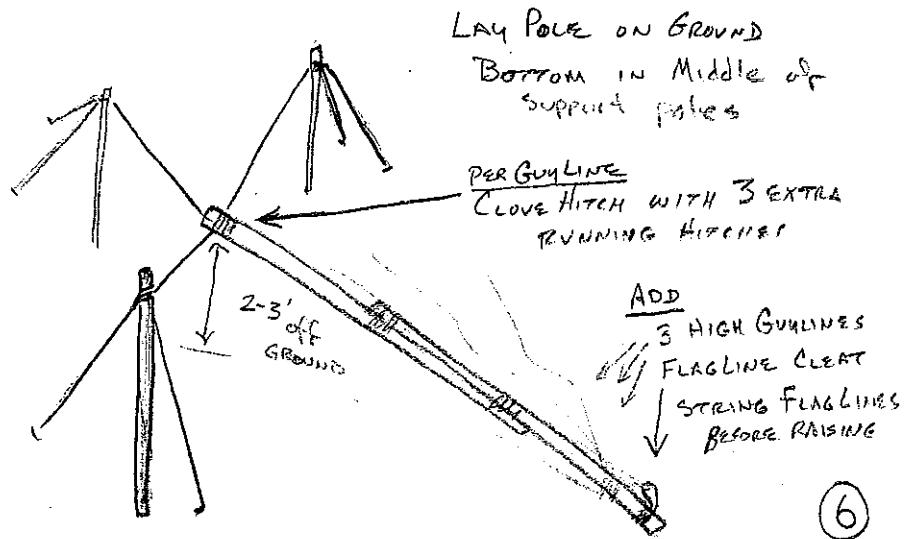

RAISE TO VERTICAL

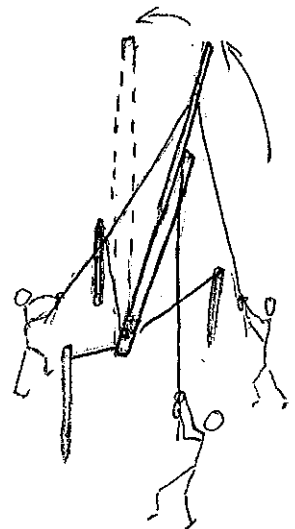

HOIST POLE OFF GROUND  
SUPPORT USING HIGHER  
GUYLINES  
SECURE EACH TO RESPECTIVE  
SUPPORT POLE - SEE STEP 5 7

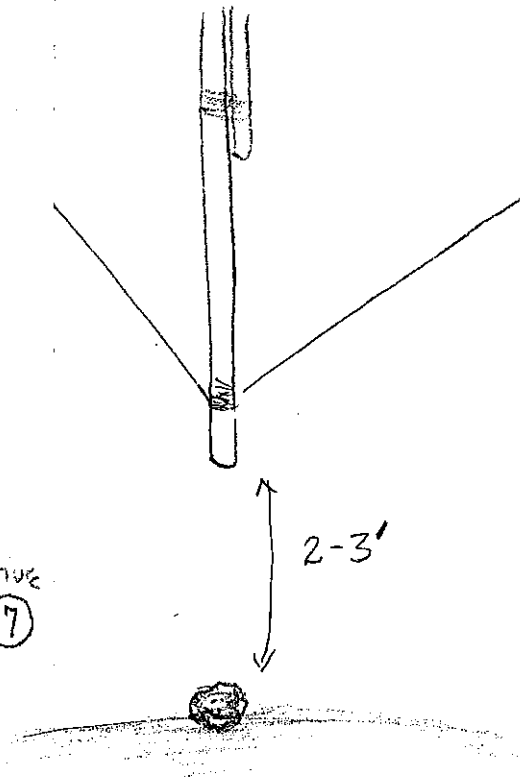

PLACE ROCK BELOW  
TO ADD DIMENSION

8

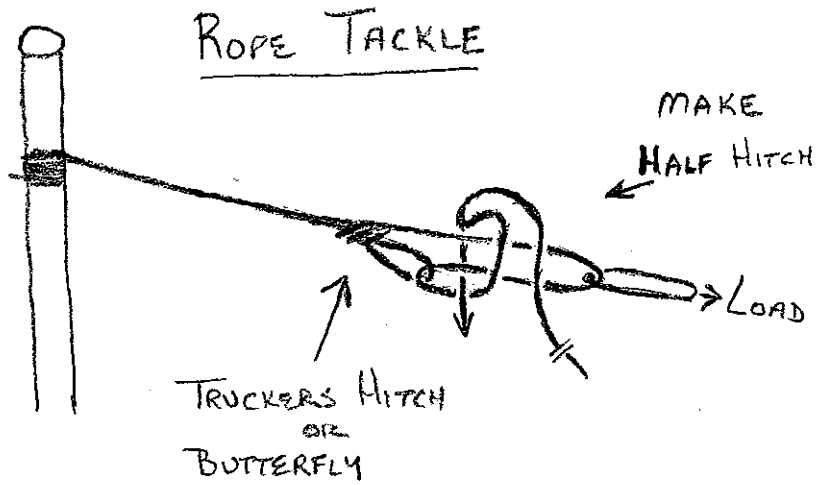

9

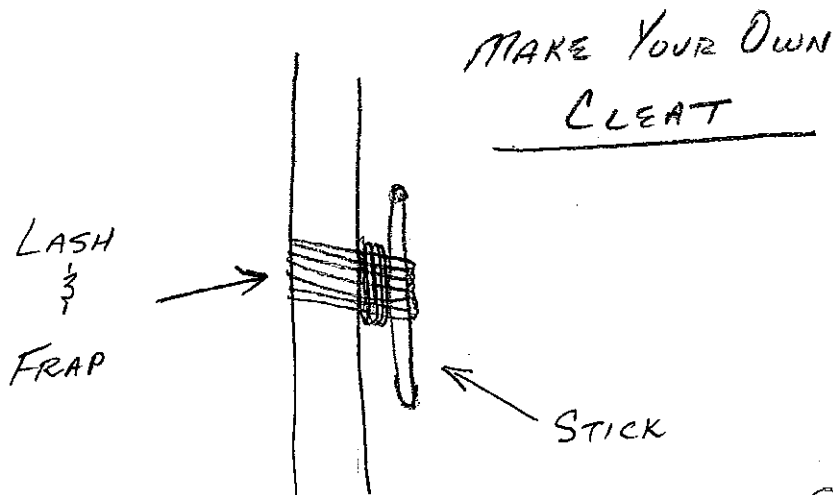

10

INSTRUCTIONS AND DIAGRAMS

By DAVE OSBORNE  
TROOP 750  
MARIETTA GA

IF IT DIDN'T WORK...  
BLAM BOB!

11